

- 15G0093B130 -

Profinet Card

INSTRUCTIONS

For ASA 4.0 Basic/ASA 4.0 Advanced

Issued on 15/08/21

R. 02

- This manual is integrant and essential to the product. Carefully read the instructions contained herein as they provide important hints for use and maintenance safety.
- This device is to be used only for the purposes it has been designed to. Other uses should be considered improper and dangerous. The manufacturer is not responsible for possible damages caused by improper, erroneous and irrational uses.
- Enertronica Santerno is responsible for the device in its original setting.
- Any changes to the structure or operating cycle of the device must be performed or authorized by the Engineering Department of Enertronica Santerno.
- Enertronica Santerno assumes no responsibility for the consequences resulting by the use of non-original spareparts.
- Enertronica Santerno reserves the right to make any technical changes to this manual and to the device without prior notice. If printing errors or similar are detected, the corrections will be included in the new releases of the manual.
- The information contained herein is the property of Enertronica Santerno and cannot be reproduced. Enertronica Santerno enforces its rights on the drawings and catalogues according to the law.



Enertronica Santerno S.p.A.

Via della Concia, 7 - 40023 Castel Guelfo (BO) Italy

Tel. +39 0542 489711 – Fax +39 0542 489722

www.santerno.com - info@santerno.com

Compatibility

This manual is suitable for:

- Profinet Card
- Profinet Card with Ground Fault

These cards are suitable for use with ASA4.0 soft starters.

Product description	Soft starter name
Basic model	ASA4.0 B
Advanced model	ASA4.0 A

The available features may vary according to the model and version of the starter.

For the latest manuals and software, please visit our website.

Contents

1	Introduction	2
2	Installation	3
3	Device configuration	4
4	Master configuration	8
5	Ground fault protection	8
6	Operation	9
7	Packet structures	10
8	Network design.....	18
9	Specifications	20

Disclaimer

The examples and diagrams in this manual are included solely for illustrative purposes. The information contained in this manual is subject to change at any time and without prior notice. In no event will responsibility or liability be accepted for direct, indirect or consequential damages resulting from the use or application of this equipment.

Failure to follow the information and instructions in this manual will void the warranty.

Warnings

It is the installer's responsibility to follow all instructions in this manual and to follow correct electrical practice.



WARNING

For your safety, isolate the soft starter completely from mains voltage before attaching or removing accessories.



WARNING

Inserting foreign objects or touching the inside of the starter while the expansion port cover is open may endanger personnel, and can damage the starter.

1 Introduction

1.1 Product design

The Profinet Card allows the soft starter to connect to an Ethernet network and be controlled or monitored using an Ethernet communication model.

Familiarity with Ethernet protocols and networks is required to operate the device successfully. For difficulties using this device with third party products, including PLCs, scanners and commissioning tools, contact the relevant supplier.

1.2 Connections

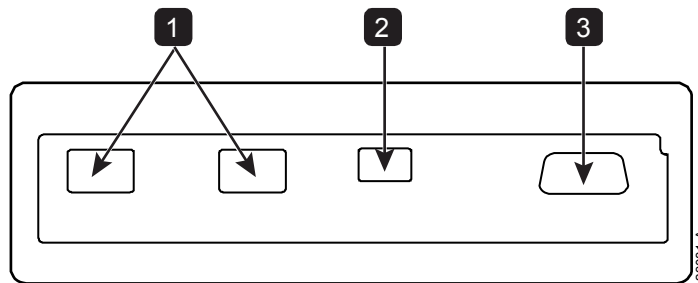

1	2 x RJ45 ethernet ports, supporting line, star, ring and loop network topologies
2	2 pin connector for ground fault CT (selected models)
3	DB9 connector for optional remote keypad

1.3 Network connection

The Profinet Card supports the following protocols:

Profinet	Industrial ethernet via Profinet
MQTT	Message Queue Telemetry Transport
OPC UA	Open Platform Communications Unified Architecture

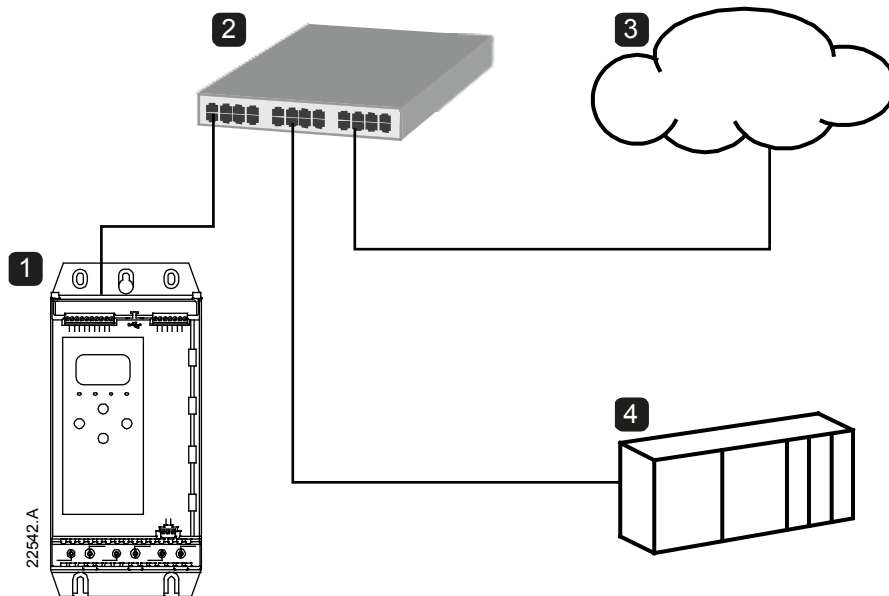

1	Soft starter
2	Network switch
3	IoT connection (MQTT/OPC UA)
4	Industrial ethernet connection to programmable logic controller

2 Installation

2.1 Installing the expansion card

1. Push a small flat-bladed screwdriver into the slot in the centre of the expansion port cover, and ease the cover away from the starter.
2. Line up the card with the expansion port. Gently push the card along the guide rails until it clicks into the starter.

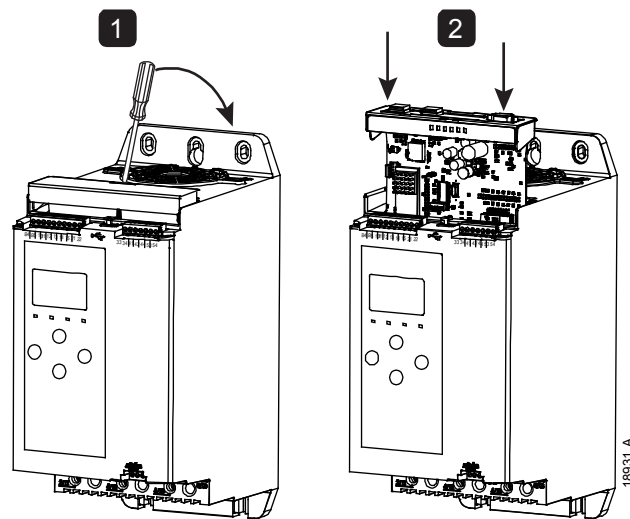

2.2 Network connection

Ethernet ports

The device has two Ethernet ports. If only one connection is required, either port can be used.

Cables

Use Category 5, 5e, 6 or 6e cable to connect to the device.

EMC precautions

To minimise electromagnetic interference, Ethernet cables should be separated from motor and mains cables by 200 mm.

If the Ethernet cable must cross motor or mains cables, the crossing should be at an angle of 90°.

2.3 Network establishment

The controller must establish communications directly with each device before the device can participate in the network.

2.4 Addressing

Each device in a network is addressed using a MAC address and a device name. The MAC address is fixed within the device and is printed on a label on the front of the device.

3 Device configuration

3.1 Configure the device name

Use the Ethernet Device Configuration Tool to configure the device. The Ethernet Device Configuration Tool is available from your local supplier.

To identify the device using the Ethernet Device Configuration Tool:

1. Start the Ethernet Device Configuration Tool.
2. Click on Search Devices. The software will search for connected devices.

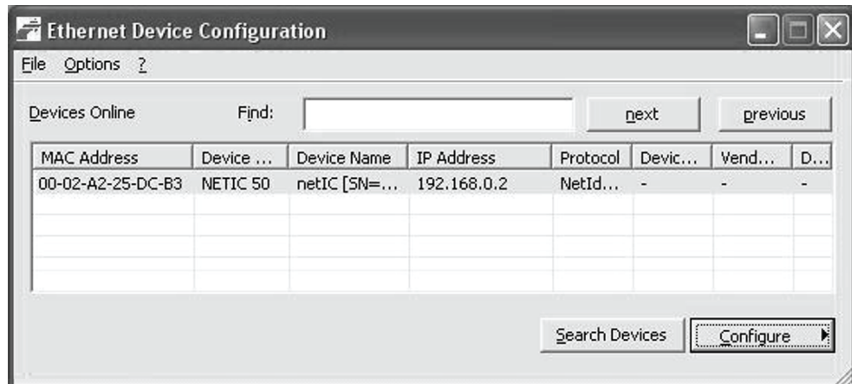

3. To configure a device name, click Configure then select Device Name.

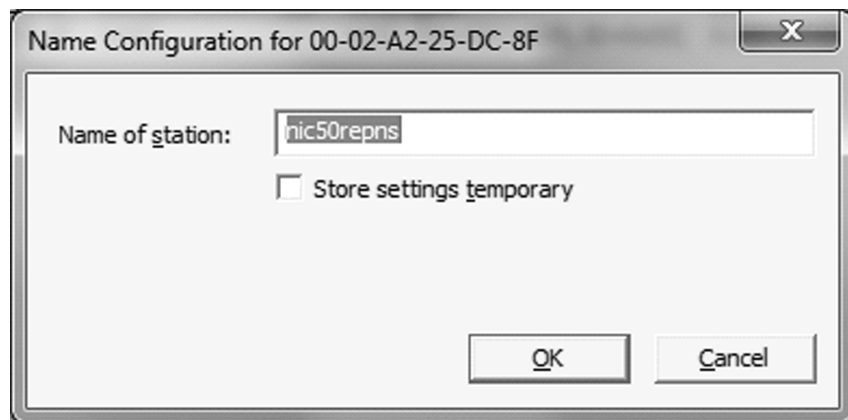

NOTE

The Error LED is on if the device is not configured. If the device is configured but is not passing I/O data, the Error LED will flash. The Error LED will be active during the configuration process.



NOTE

If your PC has a firewall enabled, you must add the tool to the list of authorised programs.

3.2 Enabling network control

The soft starter will only accept commands from the Profinet Card if parameter 1A *Command Source* is set to 'Network'.



NOTE

If the reset input is active, the starter will not operate. If a reset switch is not required, use parameter 7I to set the reset input to normally open or fit a link across terminals 10, 11 on the soft starter.

3.3 On-board web server

Settings in the Profinet Card can be configured via the card's web server.

Connect to the device

To configure settings using the on-board web server, the card must be installed in a soft starter, control power must be available, and the card and computer must both be connected to the Ethernet network.

The computer must use a fixed IP address (not DHCP) and the same subnet mask as the card. The default IP address for the card is 192.168.0.2. The default subnet mask is 255.255.255.0.

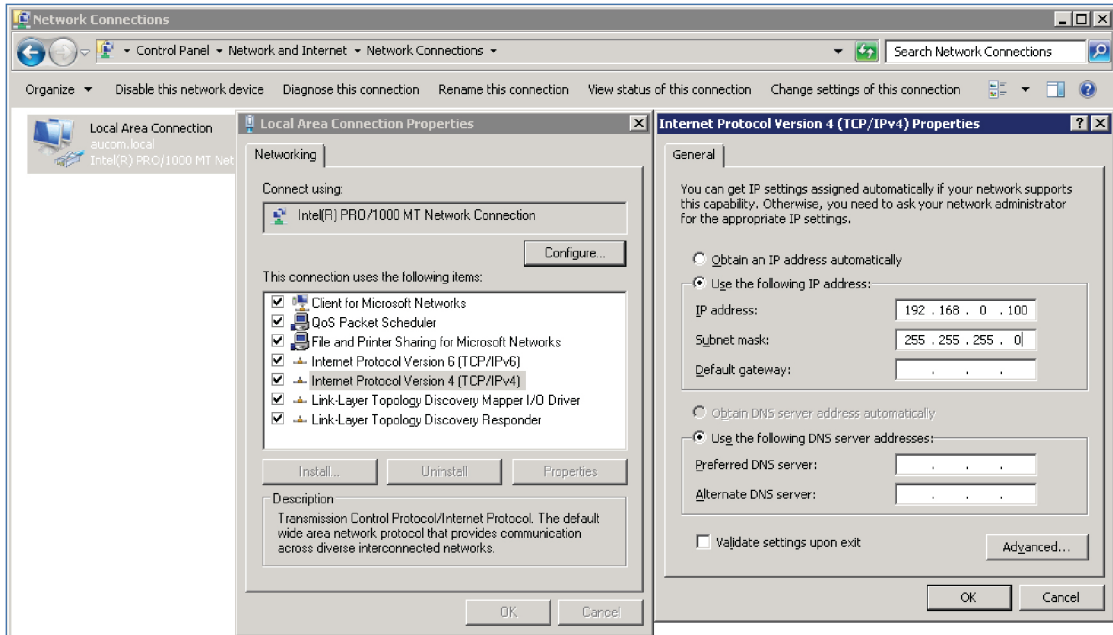

20543.A

Once connected, the web server reports basic information about the card and the soft starter.

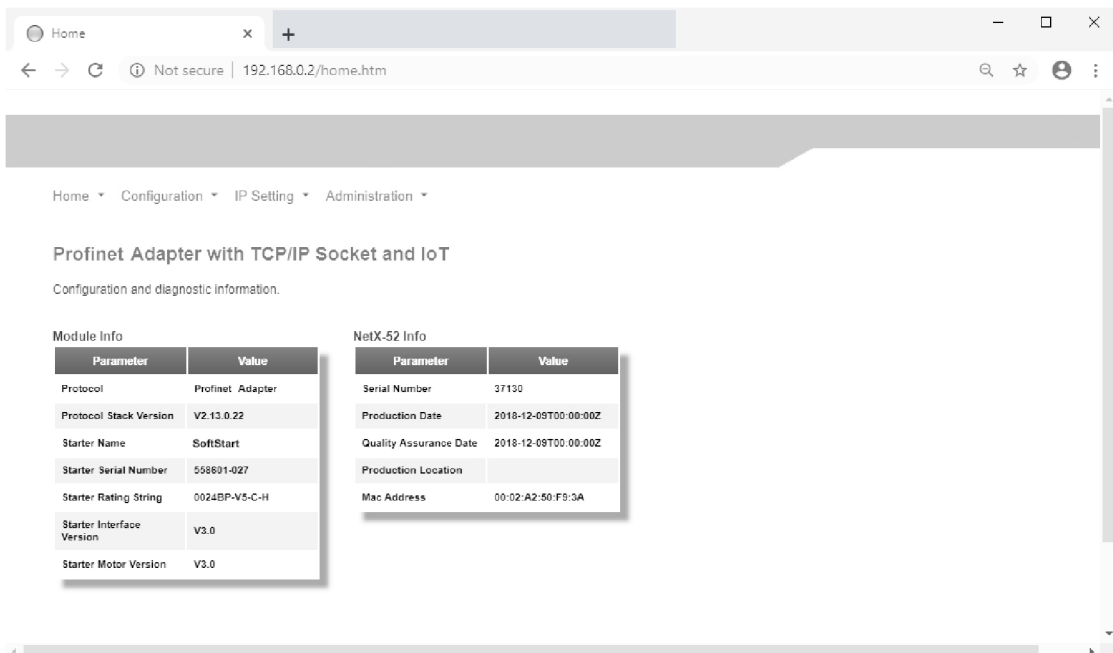

22533.A

Manage users and passwords



NOTE

For security reasons, we recommend that you define a custom administrator ID and password.

The default username and password are:

username: admin

password: 1978



NOTE

Version 2.x of the Profinet Card does not support custom users.

The Profinet Card supports multiple users and levels of privilege.

- Users can view the home screen and IP address settings
- Supervisors can view the home screen and IP settings and can change configuration settings
- Administrators can view the home screen, change configuration settings and add or delete users

To add a new user:

1. Connect to the web server then click Administration.
2. Click Create new user.
3. Enter the new username and password then click Create an account.
4. Set privileges (user, supervisor, administrator) as appropriate.
5. Click Save changes.

The screenshot shows a web browser window with the URL `192.168.0.2/home.htm?pagelD=UserPasswordManagement`. The navigation menu includes Home, Configuration, IP Setting, and Administration (1). Below the menu is the 'User Accounts' section with a table:

User name	Administrator	Supervisor	User
admin	<input checked="" type="checkbox"/>	<input checked="" type="checkbox"/>	<input checked="" type="checkbox"/>
_admin	<input checked="" type="checkbox"/>	<input checked="" type="checkbox"/>	<input checked="" type="checkbox"/>

Buttons for 'Create new user' (2) and 'Delete user' are visible. A 'Create new user' dialog box is open, containing the following fields:

- Name: new-user
- Password: [masked]
- Retype Password: [masked] (3)

Buttons for 'Create an account' and 'Cancel' are at the bottom of the dialog. A 'Save changes' button (5) is located to the right of the dialog.

To delete a user:

1. Connect to the web server then click Administration.
2. Click the required entry in the user list then click Delete user. Click Delete again to confirm the action.

Configure IoT settings

The Profinet Card supports soft starter status monitoring over IoT. The card cannot control or program the soft starter.



NOTE

Version 2.x of the Profinet Card does not support IoT operation.

- **Configure MQTT settings**

1. Connect to the web server then click Configuration > MQTT Client.
2. Tick the Enable checkbox to enable MQTT client operation. The MQTT client is enabled by default.
3. Click Connection then configure the settings as required.
4. Use Connection > Actions to select which information the card will publish.
5. Click Submit to save all settings in the card.

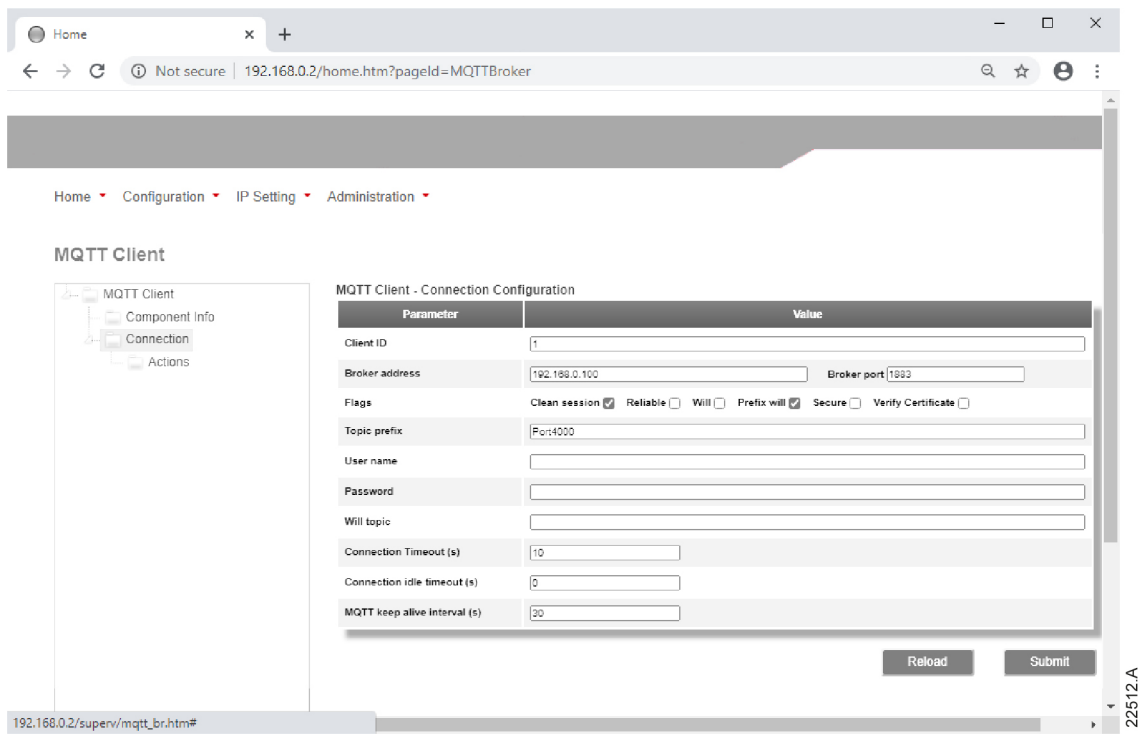

- **Configure OPC UA settings**

1. Connect to the web server then click Configuration > OPC UA Server.
2. Tick the Enable checkbox to enable OPC UA client operation. The OPC UA client is enabled by default.
3. Click Server Configuration then configure the settings as required.
4. Use Actions to select the actions for different object instances.
5. Click Submit to save all settings in the card.

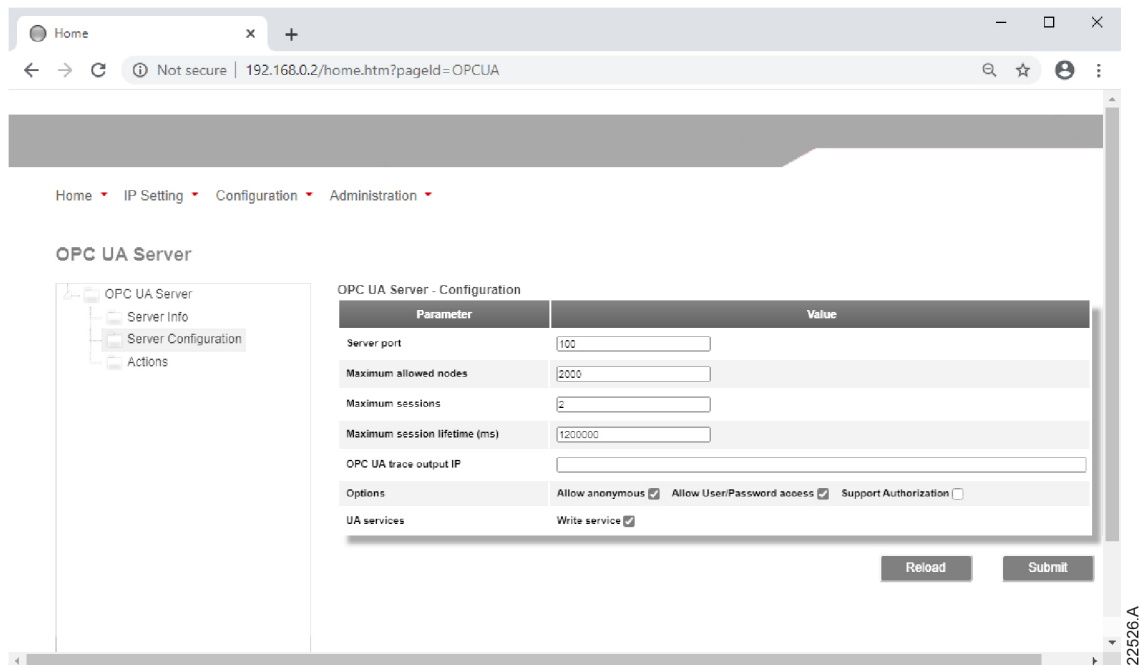

4 Master configuration

Import the latest GSDML file into your Master configuration tool. This file is available from your supplier.

If your Master uses on-screen icons, two graphic bitmap files are available from the website. SSPM_N.bmp indicates normal mode. SSPM_D.bmp indicates diagnostic mode.

5 Ground fault protection



NOTE

Ground fault protection is only available on ground fault enabled cards, with soft starters running a compatible version of software. Contact your supplier for assistance.

5.1 Overview

The Profinet Card can detect ground current and trip before the equipment is damaged.

Ground fault protection requires a 1000:1 or 2000:1 current transformer (not supplied). The CT should be rated 1 VA or 5 VA. The soft starter can be configured to trip at 1 A~50 A. If ground fault current rises above 50 A, the soft starter will trip immediately.

Parameter 40C *Ground Fault Trip Active* selects when ground fault protection is active.

5.2 Connect the CT to the ground fault inputs

To use ground fault protection, a common mode current transformer (CT) must be installed around all three phases. Use a 1000:1 or 2000:1 CT with rating of 1 VA or 5 VA and set parameter 40E *Ground Fault CT Ratio* to match. Connect the CT to the ground fault terminals (G1, G2, G3).

For maximum protection, the CT should be installed on the input side of the soft starter.

5.3 Configure ground fault protection settings

Ground fault protection settings must be set in the soft starter.

Parameter	Parameter name	Description
40A	<i>Ground Fault Level</i>	Sets the trip point for ground fault protection.
40B	<i>Ground Fault Delay</i>	Slows the Profinet Card's response to ground fault variation, avoiding trips due to momentary fluctuations.
40C	<i>Ground Fault Trip Active</i>	Selects when a ground fault trip can occur.
40D	<i>Ground Fault Action</i>	Selects the soft starter's response to the protection event.
40E	<i>Ground Fault CT Ratio</i>	Set to match the ratio of the ground current measuring CT.

6 Operation

The device has been designed for use in a system complying with the Profinet standard. For successful operation, the controller must also support all functions and interfaces described in this document.

6.1 Device classification

The Profinet Card is a Profinet IO-Device and must be managed by an IO-Controller over Ethernet.

6.2 Ensuring safe and successful control

Data written to the device will remain in its registers until the data is overwritten or the device is reinitialised.

If the soft starter may be controlled via Command Override (parameter 7A) or may be disabled via the reset input (terminals 10, 11) fieldbus commands should be cleared from the registers. If a command is not cleared, it will be re-sent to the starter once fieldbus control resumes.

6.3 Feedback LEDs

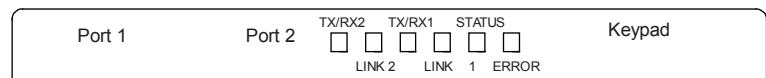

LED name	LED Status	Description
Power	Off	Device is not powered up.
	On	Device is receiving power.
Error	Off	No error.
	Flashing	Connection not established.
	On	No physical link or slow physical link. No configuration.
Status	Off	No error.
	Flashing	DCP signal service initiated via the bus.
Link x	Off	No network connection.
	On	Connected to a network.
TX/RX x	Flashing	Transmitting or receiving data.

7 Packet structures



NOTE

The available features and parameter details may vary according to the model and software version of the starter. Refer to the soft starter user manual for details of parameters and supported features.

7.1 Control commands (controller to device)

Use output bytes 0-1 to send a control command to the soft starter.

Byte	Bits	Details
0	0 to 1	<i>Reserved</i>
	2 to 3	0 = Use soft starter remote input to select motor set 1 = Use primary motor set when starting 2 = Use secondary motor set when starting 3 = <i>Reserved</i>
	4	0 = stop action will be as selected in the soft starter 1 = stop action will be a coast to stop
	5 to 7	<i>Reserved</i>
1	0	0 = Stop 1 = Start
	1 to 2	<i>Reserved</i>
	3	1 = Reset
	4 to 7	<i>Reserved</i>
2 to 5		Parameter management (see <i>Parameter Management</i> on page 14)

7.2 Status information (device to controller)

Starter status information is always available when the device is active.

Bytes 0-1: Control status

Bits	Details
0 to 5	Current (% motor FLC)
6	Command source 0 = Network, Timer 1 = Remote Keypad, Digital Input, Clock
7	1 = Ramping (starting or stopping)
8	1 = Ready
9	1 = Starting, running or stopping
10	1 = Tripped
11	1 = Warning
12 to 15	<i>Reserved</i>

Bytes 2-3: Starter state

Bits	Details
0 to 3	The decimal value of bits 0~3 indicates the starter's state: 0 = Communication error between device and soft starter 1 = Ready 2 = Starting 3 = Running 4 = Stopping 5 = Not ready (restart delay, restart temperature check, run simulation, reset input is open) 6 = Tripped 7 = Menu open (cannot start) 8 = Jog forward 9 = Jog reverse
4	0 = Negative phase sequence 1 = Positive phase sequence
5	1 = Current exceeds FLC
6	0 = Uninitialised 1 = Initialised
7	1 = Communication error between device and soft starter
8 to 15	<i>Reserved</i>

Bytes 4-5: Trip code

Bits	Details
0 to 15	See <i>Trip Codes</i> on page 15

Bytes 6-7: Motor current

Bits	Details
0 to 15	Average rms current across all three phases

Bytes 8-9: Motor temperature

Bits	Details
0 to 15	Motor thermal model (%)

Bytes 10-63: Extended information

Bytes 10~63 report information from the soft starter's internal registers.

Byte	Description	Bits	Details
10-11	Version	0 to 8	<i>Reserved</i>
		9 to 15	Product type code: 12 = Basic model 13 = Advanced model
12-13	Model number	0 to 7	<i>Reserved</i>
		8 to 15	Soft starter model ID

Byte	Description	Bits	Details
14-15	<i>Reserved</i>		
16-17	<i>Reserved</i>		
18-19	Starter state	0 to 4	0 = <i>Reserved</i> 1 = Ready 2 = Starting 3 = Running 4 = Stopping 5 = Not ready (restart delay, restart temperature check, run simulation, reset input is open) 6 = Tripped 7 = Programming mode 8 = Jog forward 9 = Jog reverse
		5	1 = Warning
		6	0 = Uninitialised 1 = Initialised
		7	Command source 0 = Network, Timer 1 = Remote Keypad, Digital Input, Clock
		8	<i>Reserved</i>
		9	0 = Negative phase sequence 1 = Positive phase sequence
		10 to 15	See <i>Trip Codes</i> on page 15
20-21	Current	0 to 13	Average rms current across all three phases
		14 to 15	<i>Reserved</i>
22-23	Current	0 to 9	Current (% motor FLC)
		10 to 15	<i>Reserved</i>
24-25	Motor temperature	0 to 7	Motor thermal model (%)
		8 to 15	<i>Reserved</i>
26-27	Power	0 to 11	Power
		12 to 13	Power scale 0 = Multiply power by 10 to get W 1 = Multiply power by 100 to get W 2 = Power (kW) 3 = Multiply power by 10 to get kW
		14 to 15	<i>Reserved</i>
28-29	% Power factor	0 to 7	100% = power factor of 1
		8 to 15	<i>Reserved</i>
30-31	Voltage	0 to 13	Average rms voltage across all three phases
		14 to 15	<i>Reserved</i>
32-33	Current	0 to 13	Phase 1 current (rms)
		14 to 15	<i>Reserved</i>
34-35	Current	0 to 13	Phase 2 current (rms)
		14 to 15	<i>Reserved</i>

Byte	Description	Bits	Details
36-37	Current	0 to 13	Phase 3 current (rms)
		14 to 15	<i>Reserved</i>
38-39	Voltage	0 to 13	Phase 1 voltage (rms)
		14 to 15	<i>Reserved</i>
40-41	Voltage	0 to 13	Phase 2 voltage (rms)
		14 to 15	<i>Reserved</i>
42-43	Voltage	0 to 13	Phase 3 voltage (rms)
		14 to 15	<i>Reserved</i>
44-45	Parameter list version number	0 to 7	Parameter list minor revision
		8 to 15	Parameter list major version
46-47	Digital input state	For all inputs, 0 = open, 1 = closed (shorted)	
		0	Start/Stop
		1	<i>Reserved</i>
		2	Reset (Refer to note)
		3	Input A
		4	Input B
		5 to 15	<i>Reserved</i>
48-49	Trip code	0 to 15	See <i>Trip Codes</i> on page 15
50-51	<i>Reserved</i>		
52-53	Frequency	0 to 15	Frequency (Hz)
54-55	Ground current	0 to 15	Ground current (A)
56-59	<i>Reserved</i>		
60-63	Parameter management		See <i>Parameter Management</i> on page 14



NOTE

The reset input is normally closed by default. If parameter 71 *Reset/Enable Logic* is set to normally open, the reported state will be inverted (0 = closed, 1 = open).



NOTE

For models 0064B and smaller, current reported via communications is 10 times greater than the actual value (displayed on the keypad).



NOTE

Frequency reported via communications is 10 times greater than the actual value.

7.3 Parameter management

The Profinet Card can read parameter values from and write parameter values to the soft starter. The card handles one parameter at a time.

The device references parameters according to their position in the starter's parameter list.



NOTE

Parameter lists vary according to the model and version of soft starter. Refer to the relevant soft starter manual for a complete parameter list.



CAUTION

Changing the values of the Advanced parameters (parameter group 20) may cause unpredictable behaviour in the soft starter. Consult your local supplier before adjusting the Advanced parameters.

Output

Use output bytes 2-5 to read or write a parameter to the soft starter.

Controller > device output bytes are structured as follows.

Byte	Bits	Details
2	0 to 7	Parameter number to read/write
3	0	<i>Reserved</i>
	1	1 = Read parameter
	2	1 = Write parameter
	3 to 7	<i>Reserved</i>
4	0 to 7	Low byte parameter value to write to soft starter/ zero data values for read
5	0 to 7	High byte parameter value to write to soft starter/ zero data values for read

Input

Parameter data from the starter is reported in input bytes 60-63.

Device > controller input bytes are structured as follows.

Byte	Bits	Details
60	0 to 7	Echo parameter number
61	0	1 = Invalid parameter number
	1	1 = Invalid parameter value
	2 to 7	<i>Reserved</i>
62	0 to 7	Low byte parameter value read from soft starter
63	0 to 7	High byte parameter value read from soft starter

7.4 Trip codes

Trip code	Description
255	No trip
1	Excess start time
2	Motor overload
3	Motor thermistor
4	Current imbalance
5	Frequency
6	Phase sequence
7	Overcurrent
8	Power loss
9	Undercurrent
10	Heatsink overtemperature
11	Motor connection
12	Input A trip
13	FLC too high
14	Unsupported option (function not available in inside delta)
15	Communications card fault
16	Network communications
18	Overvoltage
19	Undervoltage
20	Ground fault
23	Parameter out of range
24	Input B trip
26	L1 phase loss
27	L2 phase loss
28	L3 phase loss
29	L1-T1 shorted
30	L2-T2 shorted
31	L3-T3 shorted
33	Time-overcurrent (Bypass overload)
34	SCR overtemperature
35	Battery/clock
36	Thermistor circuit
47	Overpower
48	Underpower
56	Keypad disconnected
57	Zero Speed Detect
58	SCR Itsm
59	Instantaneous overcurrent
60	Rating Capacity
70	Current Read Err L1
71	Current Read Err L2

Trip code	Description
72	Current Read Err L3
74	Motor Connection T1
75	Motor Connection T2
76	Motor Connection T3
77	Firing Fail P1
78	Firing Fail P2
79	Firing Fail P3
80	VZC Fail P1
81	VZC Fail P2
82	VZC Fail P3
83	Low Control Volts
84~96	Internal fault x. Contact your local supplier with the fault code (X).

7.5 Examples

Control commands (controller to device)

Start the motor using parameter set 1							
Byte 0	Byte 1	Byte 2	Byte 3	Byte 4	Byte 5	Byte 6	Byte 7
4	1						

Start the motor, select via remote input							
Byte 0	Byte 1	Byte 2	Byte 3	Byte 4	Byte 5	Byte 6	Byte 7
0	1						

Stop the motor using the programmed soft stop for motor set 2							
Byte 0	Byte 1	Byte 2	Byte 3	Byte 4	Byte 5	Byte 6	Byte 7
8	0						

Quick stop the motor							
Byte 0	Byte 1	Byte 2	Byte 3	Byte 4	Byte 5	Byte 6	Byte 7
16	0						

Reset a trip							
Byte 0	Byte 1	Byte 2	Byte 3	Byte 4	Byte 5	Byte 6	Byte 7
≤ 28	8						

Status information (device to controller)

Read control status - Ready							
Byte 0	Byte 1	Byte 2	Byte 3	Byte 4	Byte 5	Byte 6	Byte 7
0	1						

Read control status - Running							
Byte 0	Byte 1	Byte 2	Byte 3	Byte 4	Byte 5	Byte 6	Byte 7
		3	0				

Read control status - Tripped, trip code 4 (Current imbalance)							
Byte 0	Byte 1	Byte 2	Byte 3	Byte 4	Byte 5	Byte 6	Byte 7
		6	0	4	0		

Parameter management

Write parameter to starter: parameter number 2, 1B Motor Full Load Current = 55							
Byte 0	Byte 1	Byte 2	Byte 3	Byte 4	Byte 5	Byte 6	Byte 7
		2	4	55	0		
Parameter write response							
Byte 56	Byte 57	Byte 58	Byte 59	Byte 60	Byte 61	Byte 62	Byte 63
				2	0	55	0
Basic model: Read parameter number 12, 2I Stop Mode							
Byte 0	Byte 1	Byte 2	Byte 3	Byte 4	Byte 5	Byte 6	Byte 7
		12	2	0	0		
Parameter read response: parameter 2I Stop Mode = 1 (TVR Soft Stop)							
Byte 56	Byte 57	Byte 58	Byte 59	Byte 60	Byte 61	Byte 62	Byte 63
				12	0	1	0

8 Network design

The device supports star, line and ring topologies.

8.1 Star topology

In a star network, all controllers and devices connect to a central network switch.

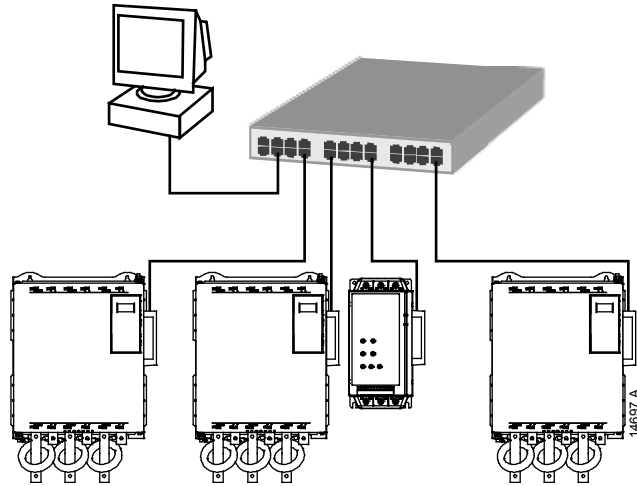

8.2 Line topology

In a line network, the controller connects directly to one port of the first card. The second Ethernet port connects to another card, which in turn connects to another device until all devices are connected.

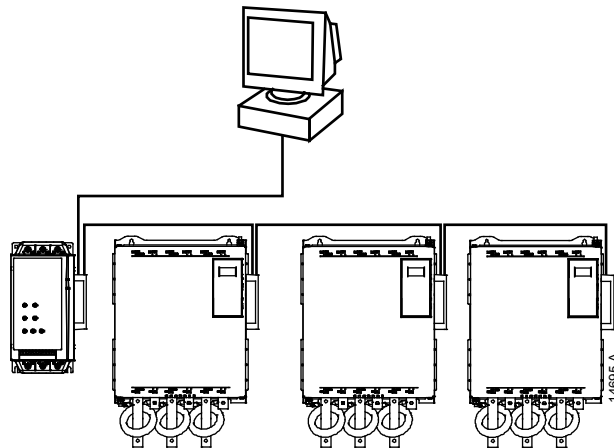

NOTE

The device has an integrated switch to allow data to pass through in line topology. The device must be receiving control power from the soft starter for the switch to operate.



NOTE

If the connection between two devices is interrupted, the controller cannot communicate with devices after the interruption point.



NOTE

Each connection adds a delay to communication with the next device. The maximum number of devices in a line network is 32. Exceeding this number may reduce the reliability of the network.

8.3 Ring topology

In a ring topology network, the controller connects to the first card, via a network switch. The second Ethernet port of the card connects to another device, which in turn connects to another device until all devices are connected. The final device connects back to the switch.

The device supports beacon based ring node configuration with MRP (media redundancy protocol).

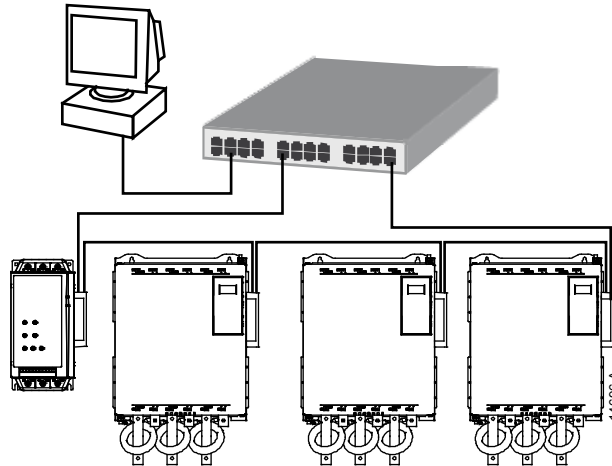

NOTE

The network switch must support loss of line detection.

8.4 Combined topologies

A single network can include both star and line components.

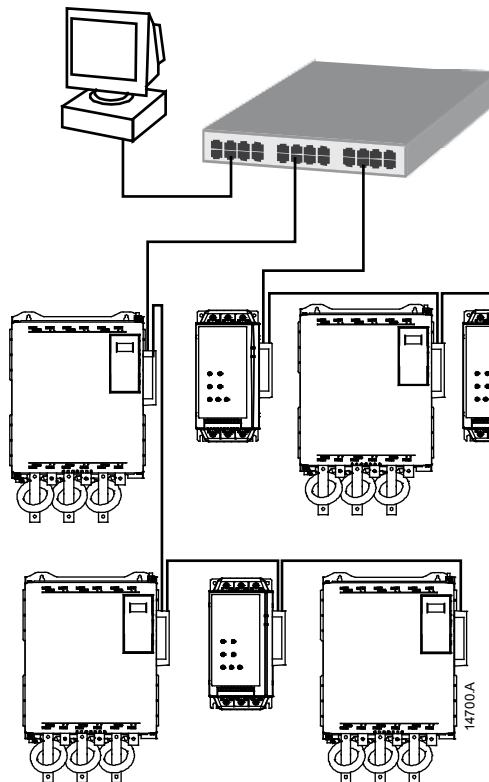

9 Specifications

Connections

Soft starter 16-way pin assembly
 Contacts Gold flash
 Network RJ45

Settings

IP Address Automatically assigned
 Device name Automatically assigned, configurable

Network

Link speed 10 Mbps, 100 Mbps (auto-detect)
 Full duplex
 Auto crossover

Power

Consumption (steady state, maximum) 35 mA @ 24 VDC
 Reverse polarity protected
 Galvanically isolated

Certification

CE EN 60947-4-2

Profibus & Profinet International  PROFIBUS · PROFINET

